

# CAR ACCESSORIES





# HISTORY OF THE COMPANY

# 2011

PKP company was founded in 2011 for the production of automotive accessories.



**> 10 years**  
on the accessories market



**> 12 000**  
of production facilities



**> 20 types**  
of products for 2021



**≈ 300**  
employees



# ISO & IATF

9001:2015 16949:2016

In 2018 quality management system of the company is certified with the requirements of ISO 9001:2015 "Quality management systems. Requirements."

The company is certified with the "Fundamental requirements for the quality management system for the automotive industry and organisations producing the appropriate service parts."

The company is OES supplier for all the products, except universal car floor mats.





# NPD PROCESS

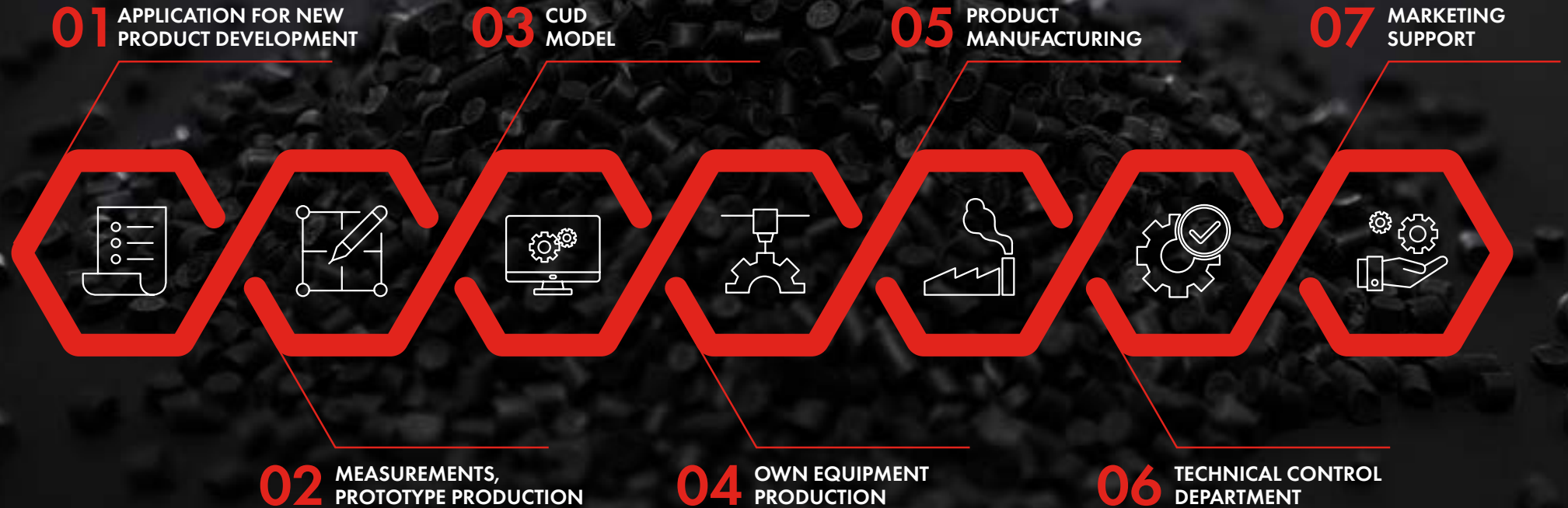



# OES

At the present time we are OES supplier and our products are officially supplied to the following brands in Russian Federation:

---

HYUNDAI VOLKSWAGEN MAZDA  
KIA MITSUBISHI MOTORS NISSAN  
TOYOTA PEUGEOT CHEVROLET  
SUBARU LADA ŠKODA RENAULT  
LEXUS AUDI CITROËN GEELY

---





# TRUNK LINERS

WITH IMPROVED OPERATIONAL CHARACTERISTICS

- Made individually for each specific model;
- usage of modern technologies - achieve the ideal form, maximally repeating the configuration of the floor;
- all technological cuts for regular fastening loops are provided.

ADVANTAGES OF TRUNK LINERS WITH TEXTURAL SURFACE:

01

Anti-slip effect prevents the trunk liner from moving out of position or moving objects in the luggage compartment;

02

Textured surface is more resistant to damage, scratches and traces of operation;

03

Presentable view due to matte surface.

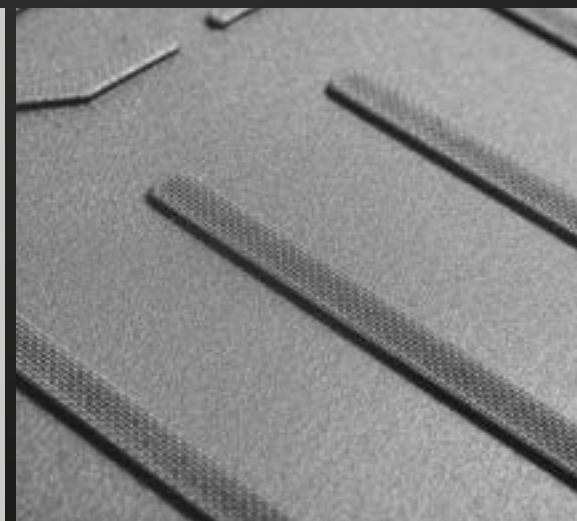
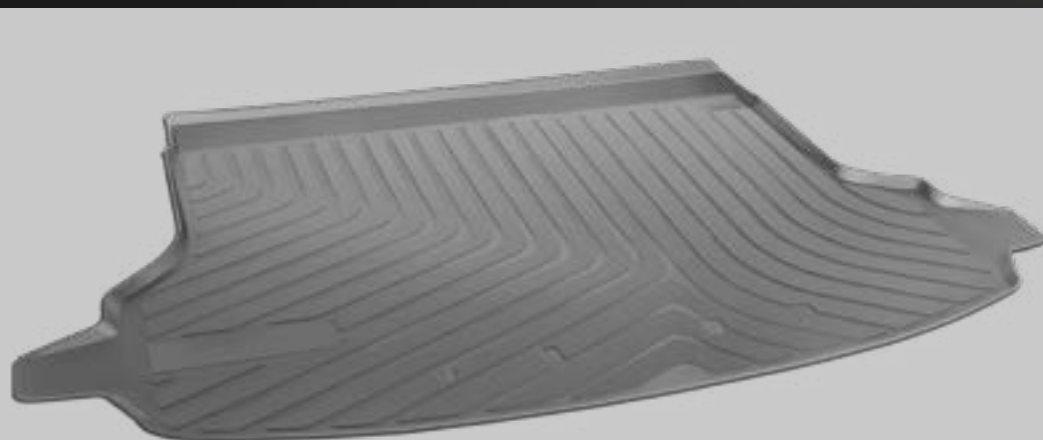



# ON A WAY TO PERFECTION

MATS WITH IMPROVED OPERATIONAL  
CHARACTERISTICS

- High-quality and environmentally-friendly materials;
- stable over a wide range of temperatures;
- no toxic odor.

ADVANTAGES OF MATS WITH  
TEXTURAL SURFACE:

- 01 Anti-slip effect due to textured surface;
- 02 Textured surface is more resistant to damage, scratches and traces of operation;
- 03 Presentable view due to matte finish;
- 04 The increased elasticity at low temperatures.

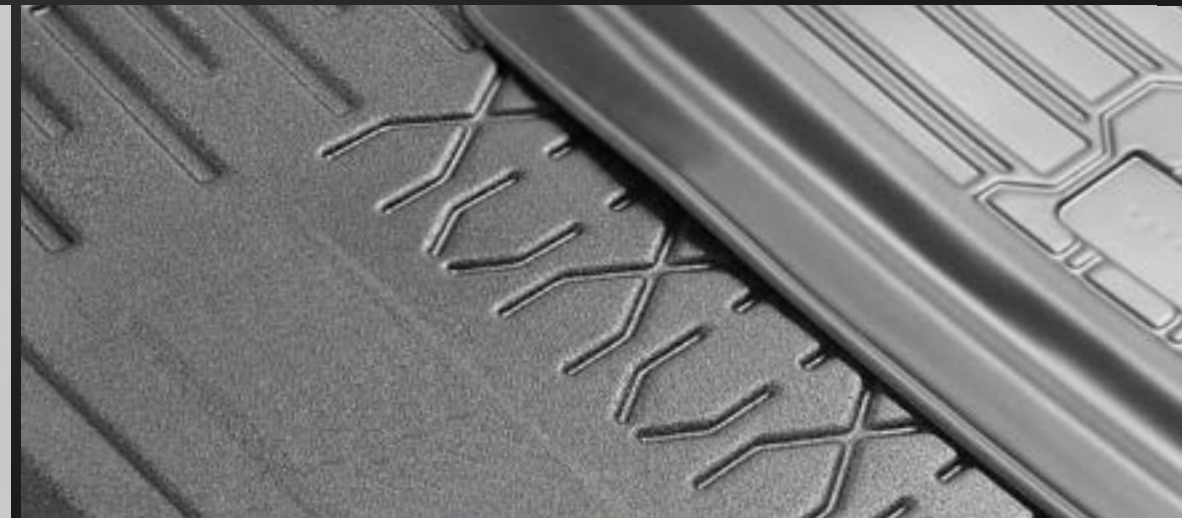
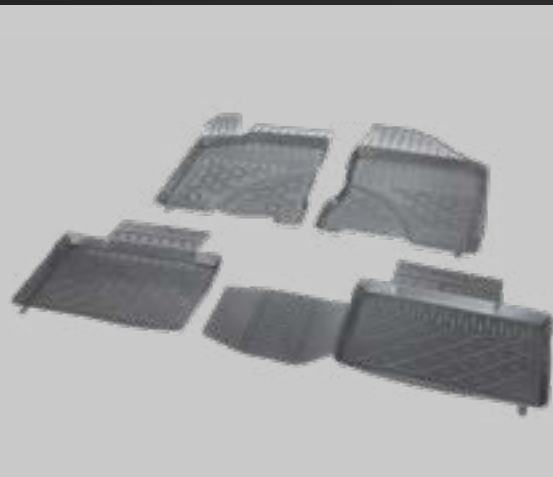



# GUARANTEED PROTECTION

5D TECHNOLOGY

Unlike conventional mats, the front part of a driver's 5D mat is a solid surface of complex shape, which allows not only to keep the foot rest area and the space under the pedals clean, but also to protect the area from dirt and moisture. Contamination when using regular-shape mats.

In addition to this, the new 5D mat design completely excludes the possibility that the projection covering the rest area will be folded back or in the wrong position.

- 01** Innovative mat configuration for guaranteed protection of sub pedal space.
- 02** Tight locking system, adapted to the use of standard fasteners.
- 03** High side, for reliable protection of the car mat from dirt and moisture.

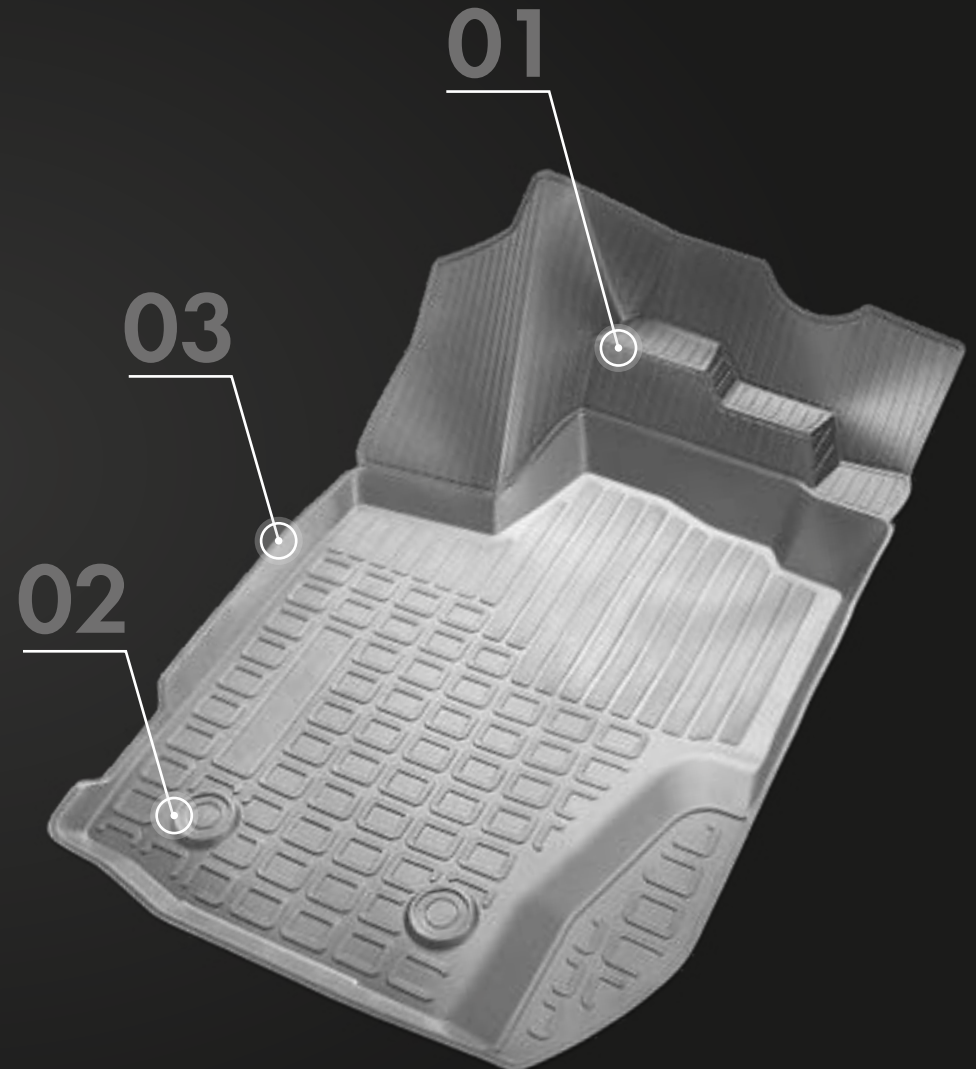





# MODEL CAR FLOOR MATS

INJECTION MOLDING TECHNOLOGY. ADVANTAGES

- 01** Consistency of the production process.  
Different parties - absolute repeatability of items;
- 02** Modern design methods increase the physical  
and mechanical characteristics of mats;
- 03** Usage of high-quality materials  
in production;

- 04** Variation of the material's texture and thickness,  
creation of double-side drawing;
- 05** Up-to-date technologies  
and automated production.





# ADVANTAGES

OF INJECTION MOLDED CAR FLOOR MATS

- 01** Reinforced area under the pedals.
- 02** Special design retaining dirt and moisture.
- 03** Personalization. The presence of the logo on the front car mats.
- 04** Reliable locking system.
- 05** High mat edges protecting against moisture and dirt.

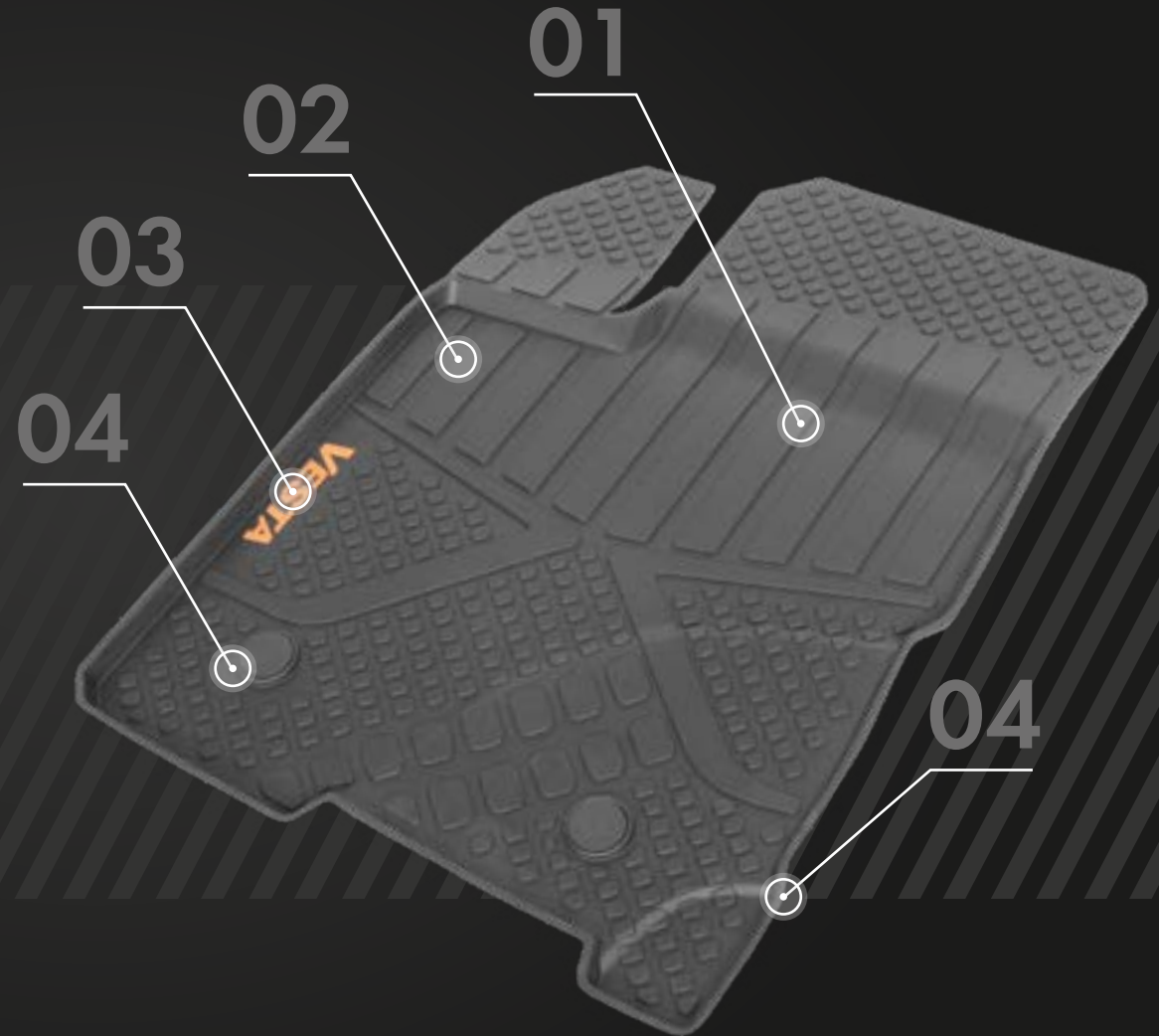



# DOUBLE-SIDED DESIGN

Injection molded technology gives an opportunity to create a double-sided car mat design.

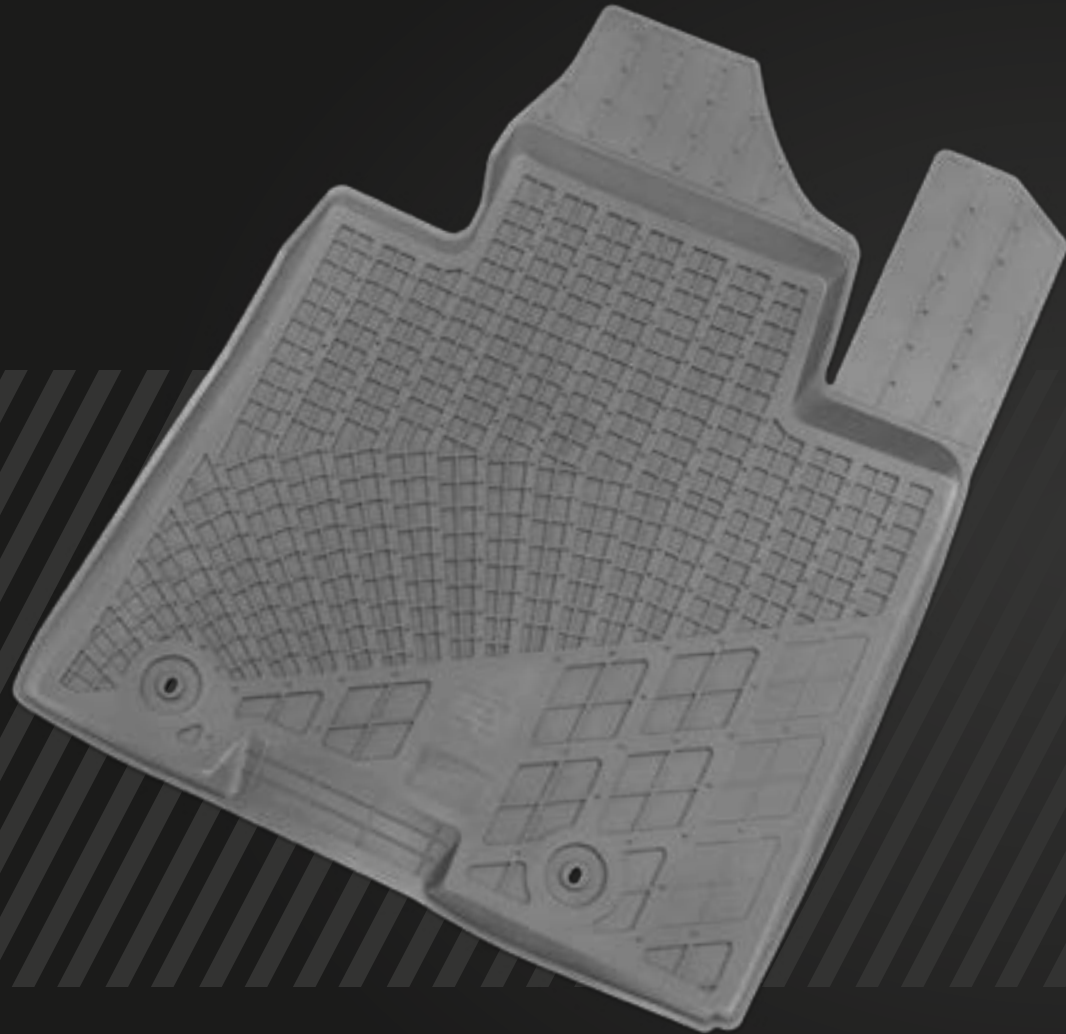

01

Each car mat has special anti-slip spikes that prevent it from shifting in the cabin from its original position.

02

Car mats are equipped with stiffeners that increase the performance and service life of products.





# UNIVERSAL CAR FLOOR MATS

WITH EDGES

Universal car floor mats (injection molding technology) with high edges provide your car with extra protection against moisture and dirt.

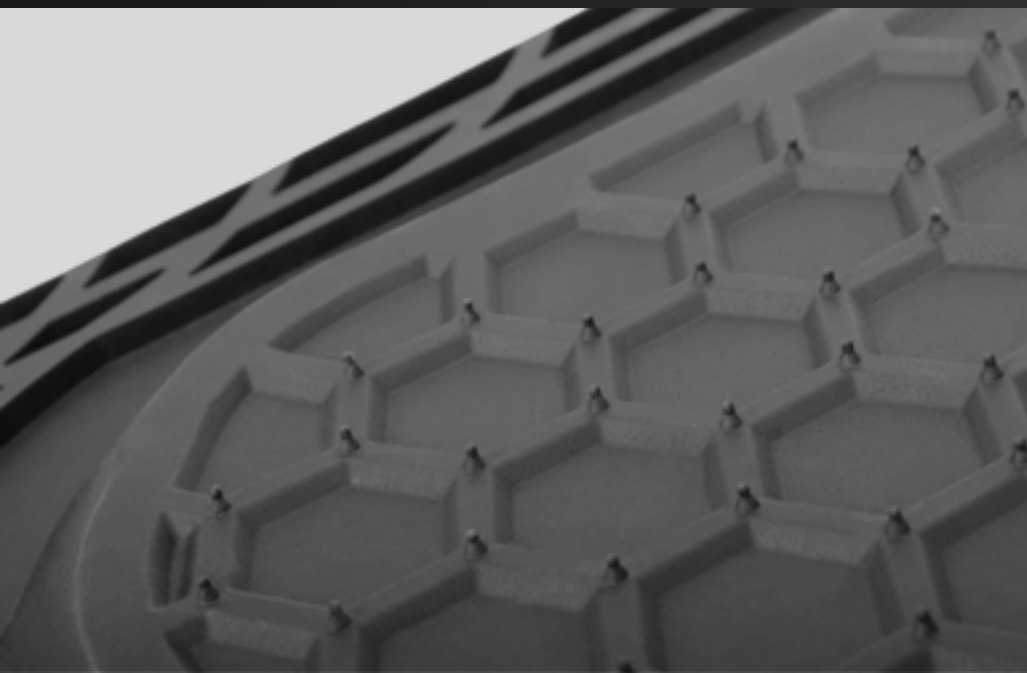



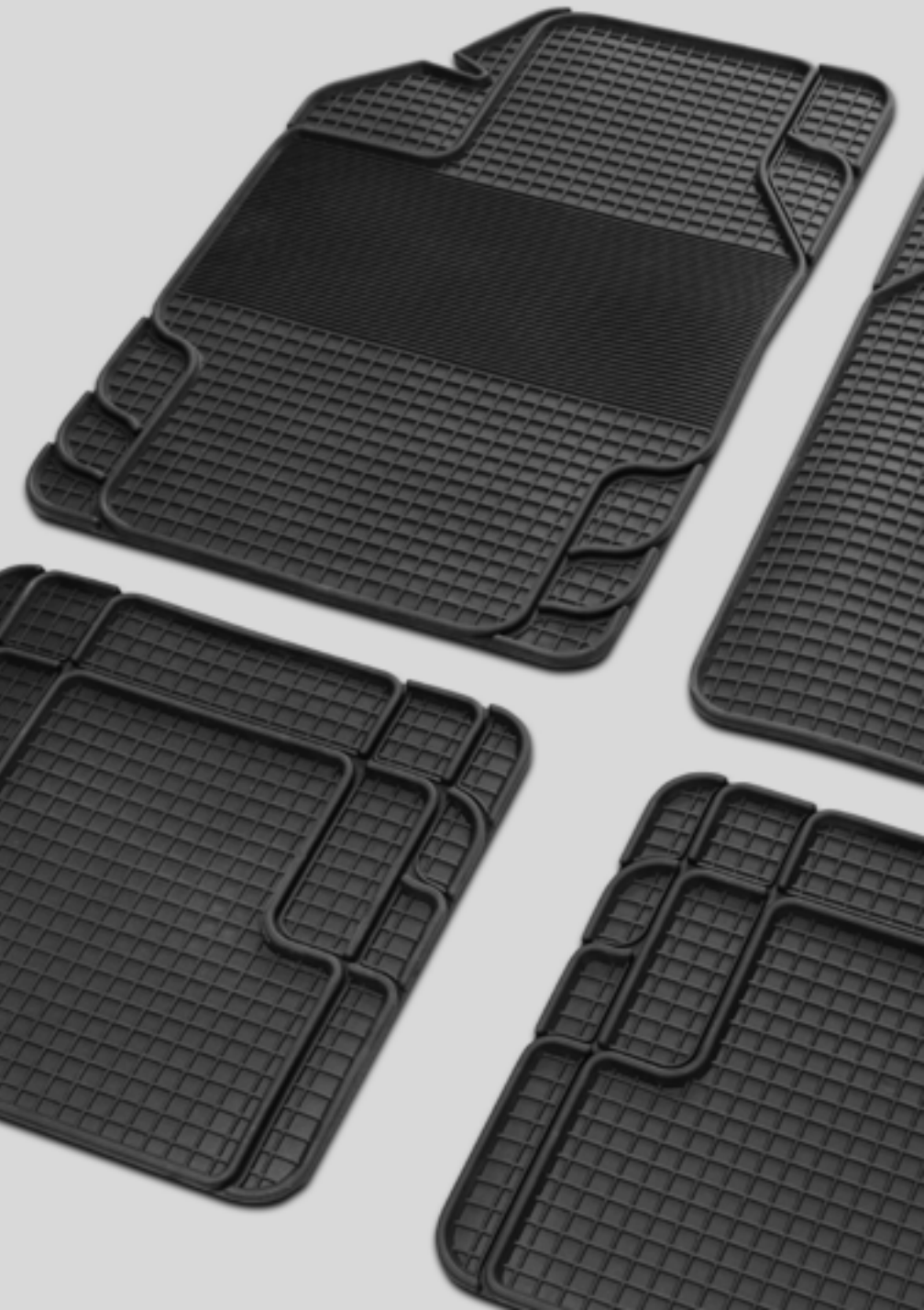

# UNIVERSAL CAR FLOOR MATS

WITHOUT EDGES

Universal car floor mats (injection molding technology) are ideal for any car, regardless of the year of manufacture and interior configuration.

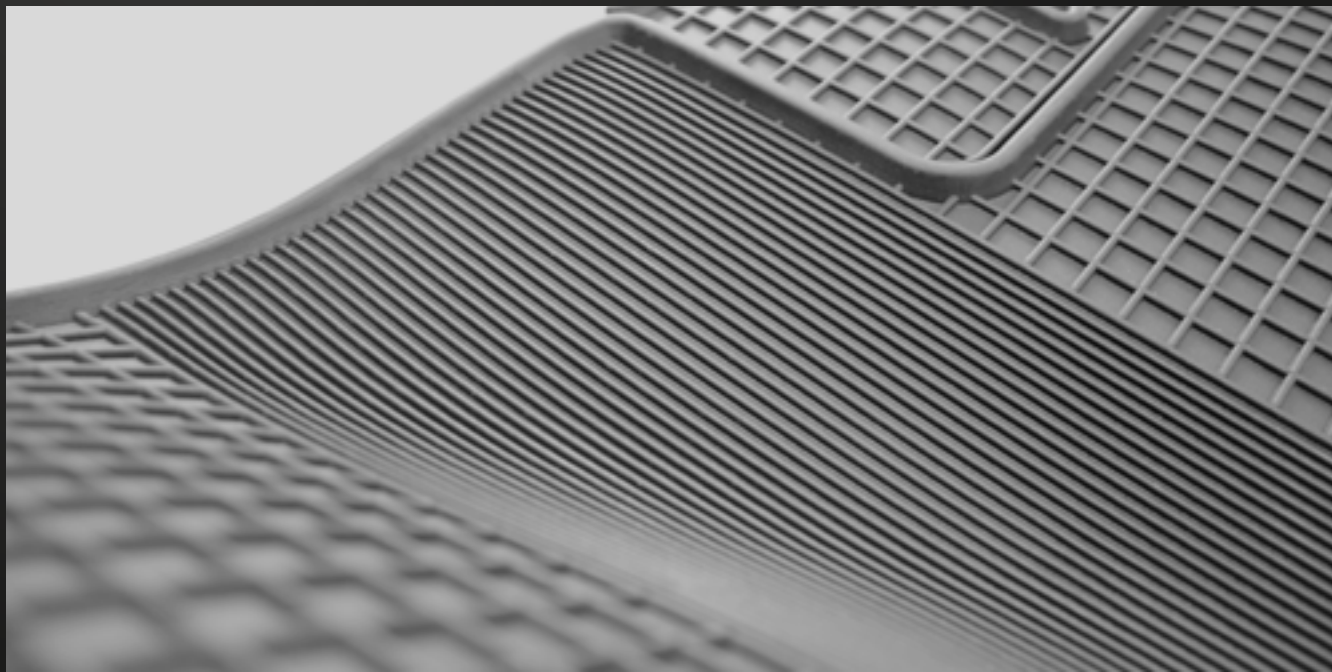





PATENTED

# COMBINED MATS

The unique technology of the combination of 2 materials allows you to achieve maximum functionality, comfort and aesthetics of textile mats.

The rubber part is made by injection molding technology providing reliable protection for the car mat.

**INNOVATIVE PRODUCT**



# COMFORT AND UTILITY

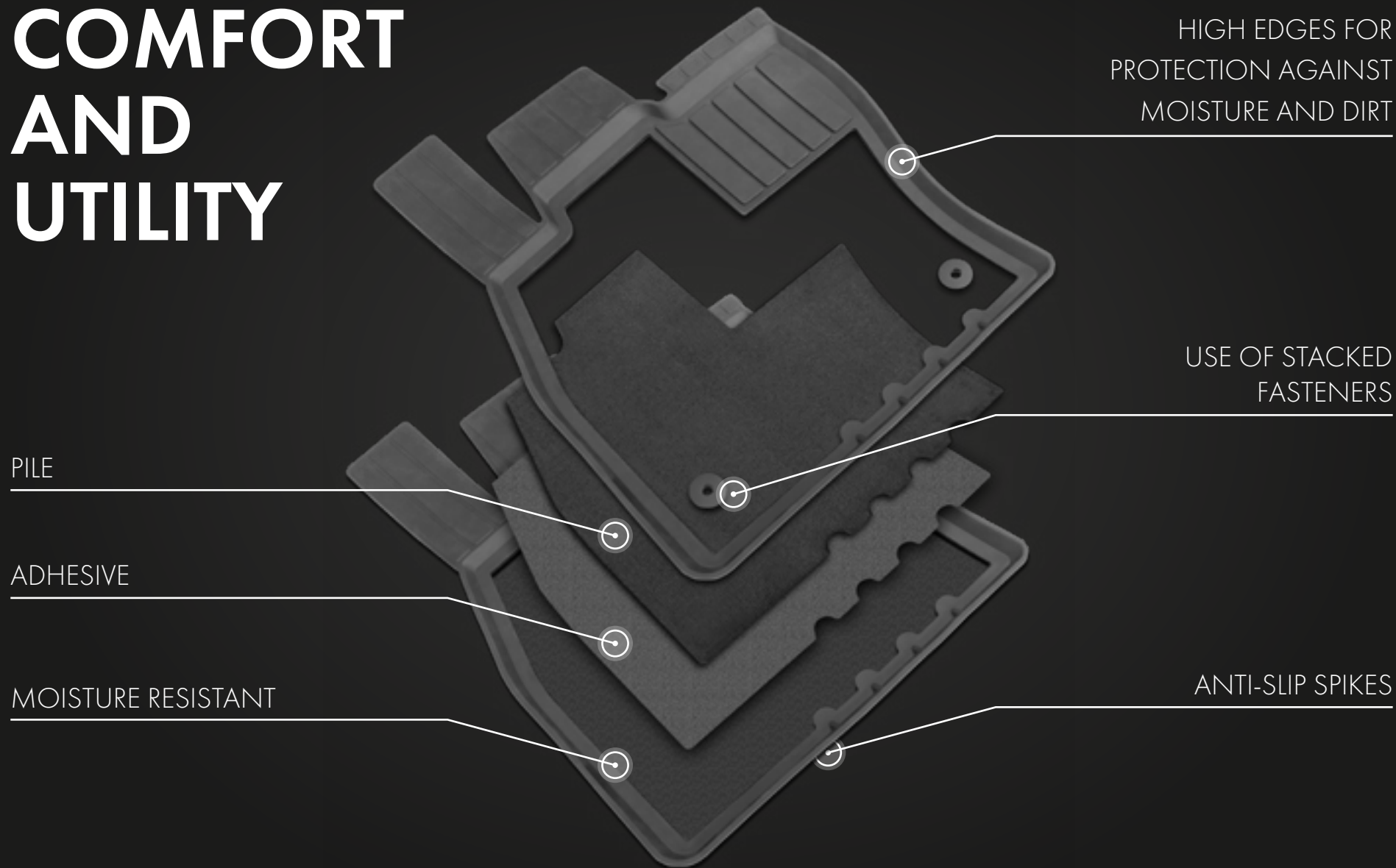

HIGH EDGES FOR  
PROTECTION AGAINST  
MOISTURE AND DIRT

USE OF STACKED  
FASTENERS

PILE

ADHESIVE

MOISTURE RESISTANT

ANTI-SLIP SPIKES

# TEXTILE MATS

Textile floor mats will reliably protect the car interior from pollution and moisture, keeping the floor covering in its original form. They are easy to clean, environmentally friendly and do not have an unpleasant odor. The unique design, color palette and diverse structure of the pile emphasize your unique style.

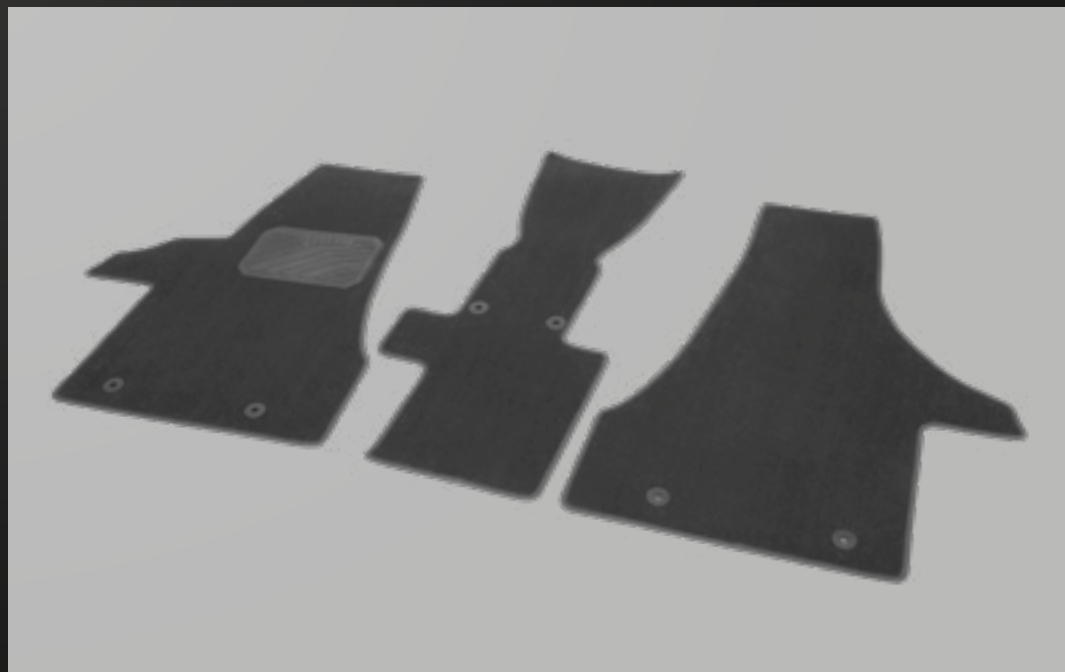

# QUALITY ASSURANCE

The use of modern three-layer materials for the production of textile mats has a positive effect on the operational characteristics, extending the service life of products.

PILE

ADHESIVE

FIBER

MOISTURE RESISTANT

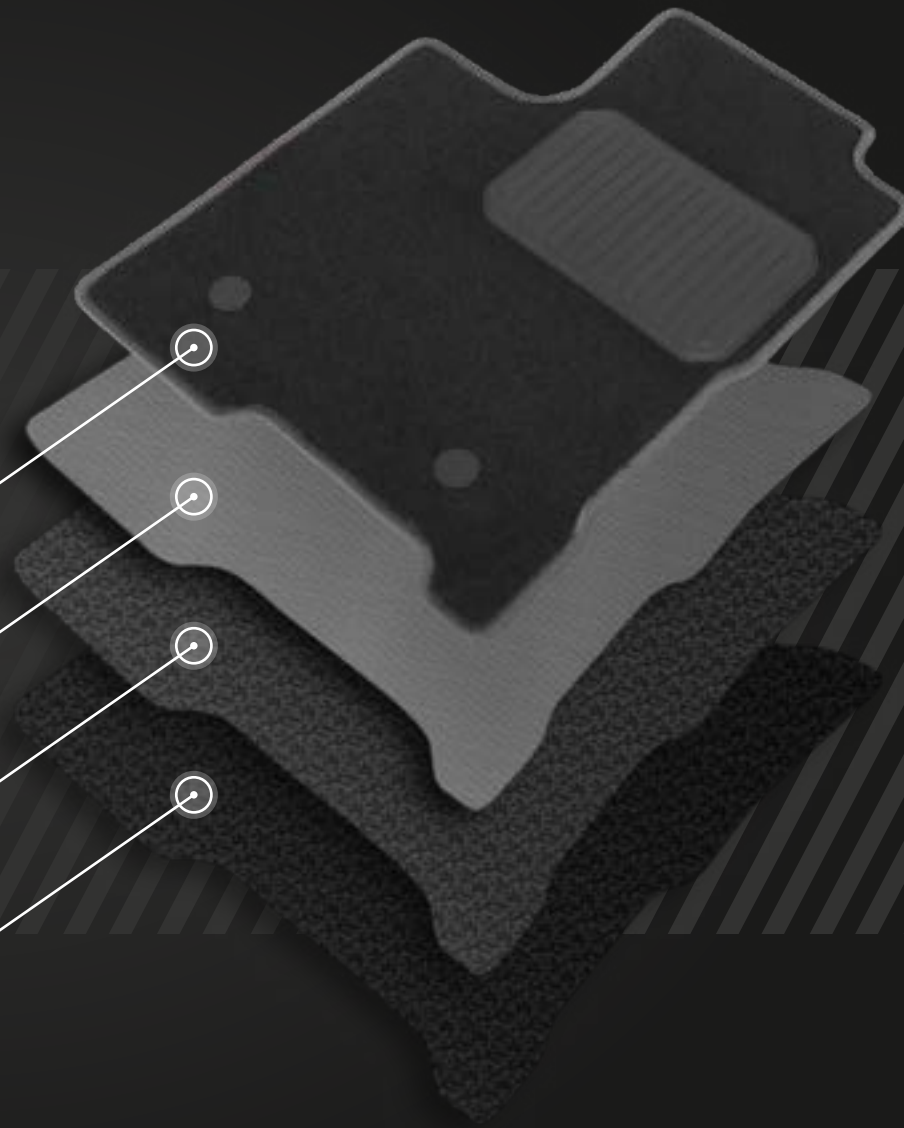



# PERSONALIZED ACCESSORIES TEXTILE MATS

TEXTILE MATS WITH COLOUR CANT /  
COLOUR THREAD / LOGO

Personalized mats with coloured lettering and contrasting braid emphasize car's individuality.

The mats completely repeat the configuration of the floor, combined with the interior of the car and the color scheme of the cabin.

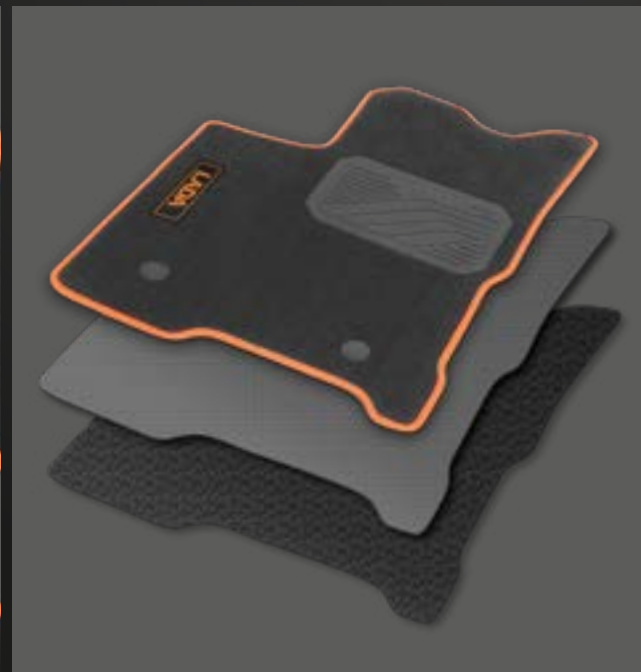





# TRUNK ORGANIZER

01

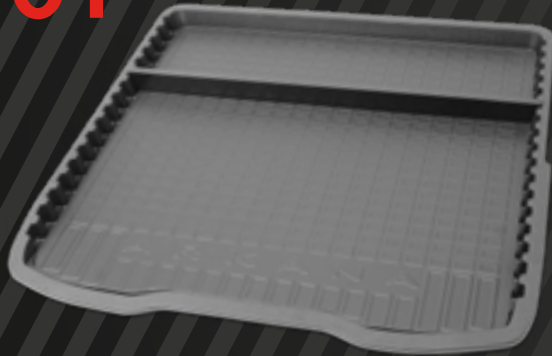

02

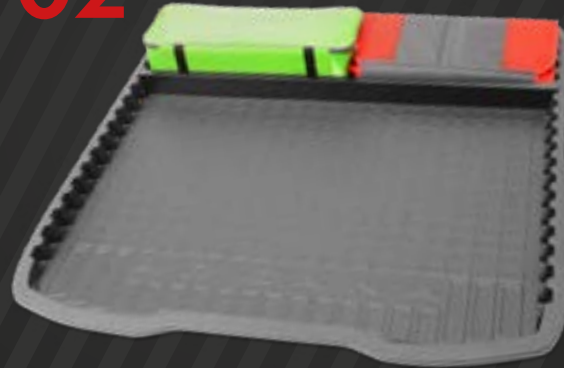

03



CREATE YOUR OWN COMFORTABLE SPACE



# IN THE ORDER OF THINGS

ADVANTAGES OF THE TRUNK ORGANIZER

- 01 Guaranteed protection of the luggage compartment from dirt and premature wear.
- 02 Functional compartment system allows you to optimize the space in the trunk.
- 03 Ability to add more dividers.
- 04 Reliable fixation of luggage items in a certain position, preventing their displacement when the vehicle is moving.





# WINDSHIELD DEFLECTORS

- 01 Designed according to the car's configuration features.
- 02 Reliable fixation system.
- 03 No effect on aerodynamic characteristics.
- 04 Provide reliable protection for side windows from dirt and moisture when the car is moving. Maintain visibility and safety on the road.

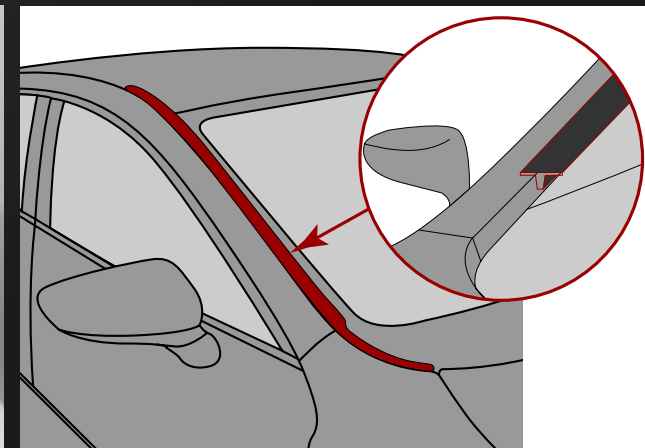



# WINDOW DEFLECTORS

INJECTION WINDOW DEFLECTORS

- 01** Environmentally friendly material, does not contain heavy metals;
- 02** Developed in accordance with international regulations UN No. 26-03 on the absence of cutting edges on the product;
- 03** Do not impair visibility and do not affect the viewing angle (according to UN Regulation No. 125);
- 04** Logo engraving.





# MUDGUARDS

INJECTION MOLDED AND VACUUM FORMED

**01** Made of eco-friendly and non-toxic material.

**02** Resistant to chemicals.

**03** Easy installation and reliable locking system.

**04** Blend harmoniously with the car appearance.

**05** Stable physical and chemical characteristics in a wide range of temperatures.

**06** Resistant to impact.

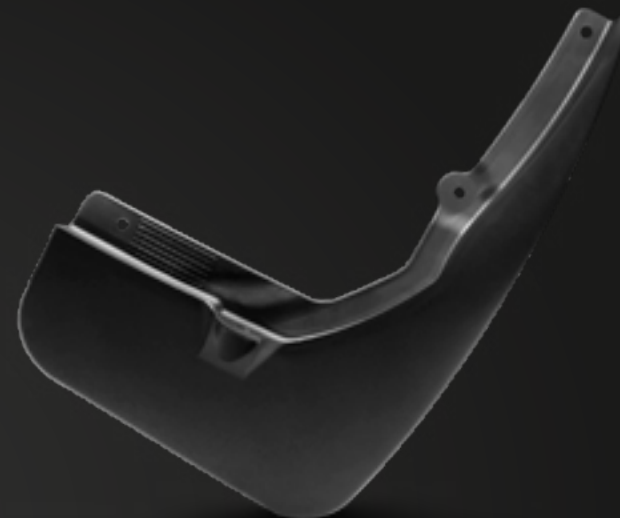





# WHEEL ARCH TRIM SETS. MOLDINGS.

INJECTION MOLDED

**01** Protect against small chips and scratches.

**02** Protect arches against the mechanical damage.

**03** Are easily installed and removed.

**04** Harmoniously combined with the appearance of the car, emphasizing its individuality.





# POLYMER PROTECTION

**01** Reliable protection and confidence on the road.

**02** Non-corrosive. Resistant to chemicals.

**03** No effect on the heat exchange processes.

**04** Eco-friendly, non-toxic material. Recyclable.

**05** Light weight of the product.



**GEARBOX  
POLYMER PROTECTION**



**POLYMER  
UNDERBODY PROTECTION**

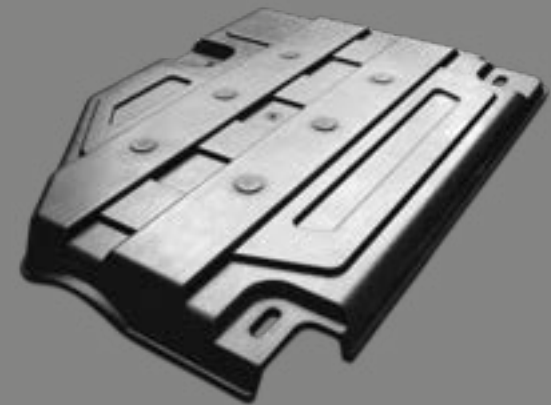

**FUEL TANK  
POLYMER PROTECTION**



Thank you for attention

**LET'S  
COLLABORATE!**

 [sf@pkplst.ru](mailto:sf@pkplst.ru)